

INSTALLATION, OPERATION &  
MAINTENANCE MANUAL  
FOR  
SERIES 380  
HH MULTISTAGE  
SPLIT CASE PUMP

15 MARCH 2005  
Copyright © 2004 American-Marsh Pumps

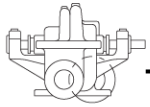

**CONTENTS**

Page #

**SAFETY CONSIDERATIONS ..... 4**

DANGER ..... 4

WARNING ..... 4

CAUTION..... 4

**PUMP IDENTIFICATION ..... 5**

MANUFACTURER ..... 5

TYPE OF PUMP ..... 5

DATE OF MANUFACTURE ..... 5

INSTALLATION, OPERATION & MAINTENANCE MANUAL IDENTIFICATION ..... 5

NAMEPLATE INFORMATION..... 5

**WARRANTY ..... 6**

**GENERAL INSTRUCTIONS..... 6**

**HANDLING AND TRANSPORT ..... 6**

METHOD OF TRANSPORT ..... 6

INSTALLATION ..... 6

**STORAGE..... 6**

SHORT-TERM STORAGE ..... 6

LONG-TERM STORAGE..... 7

**INSTALLATION & ALIGNMENT ..... 7**

FACTORY PRELIMINARY ALIGNMENT PROCEDURE..... 7

RECOMMENDED PROCEDURE FOR BASE PLATE INSTALLATION & FINAL FIELD ALIGNMENT ..... 8

    NEW GROUTED BASE PLATES ..... 8

    EXISTING GROUTED BASE PLATES..... 9

PIPING CONNECTION – SUCTION & DISCHARGE ..... 9

    SUCTION PIPING..... 10

PUMP AND SHAFT ALIGNMENT CHECK..... 12

MECHANICAL SEAL ..... 12

PACKING..... 12

PIPING CONNECTION –SEAL/PACKING SUPPORT SYSTEM ..... 12

BEARING LUBRICATION ..... 13

COUPLING ..... 13

**PUMP OPERATION ..... 14**

ROTATION CHECK..... 14

PRE START-UP CHECKS..... 14

PRIMING ..... 14

ENSURING PROPER NPSH<sub>A</sub> ..... 14

MINIMUM FLOW ..... 14

STARTING THE PUMP AND ADJUSTING FLOW ..... 15

OPERATION IN SUB-FREEZING CONDITIONS..... 16

SHUTDOWN CONSIDERATIONS ..... 16

TROUBLESHOOTING ..... 16

**MAINTENANCE..... 21**

PREVENTIVE MAINTENANCE..... 21

NEED FOR MAINTENANCE RECORDS ..... 21

NEED FOR CLEANLINESS..... 21

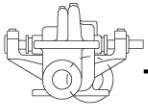

MAINTENANCE OF PUMP DUE TO FLOOD DAMAGE ..... 21

DISASSEMBLY ..... 21

*PURGE GREASE BEARING HOUSING PORTION OF ROTATING ASSEMBLY* ..... 22

*OPTIONAL RING OILED BEARING HOUSING PORTION OF ROTATING ASSEMBLY* ..... 22

*FLUID PORTION OF ROTATING ASSEMBLY* ..... 23

RE-ASSEMBLY ..... 24

*BEARING INSTALLATION* ..... 24

*FLUID PORTION OF ROTATING ASSEMBLY* ..... 25

*PURGE GREASE BEARING HOUSING PORTION OF ROTATING ASSEMBLY* ..... 25

*RING OILED BEARING HOUSING PORTION OF ROTATING ASSEMBLY* ..... 26

*INSTALLING STUFFING BOX PACKING* ..... 28

**APPENDIX A** ..... **29**

    AMERICAN-MARSH HH MAINTENANCE INSTRUCTIONS BEARING HOUSING OIL SEALS (LABYRINTH TYPE)  
    INPRO/SEAL® VBXX BEARING ISOLATORS ..... 29

**APPENDIX B** ..... **30**

    TRICO OILER INSTRUCTIONS ..... 30

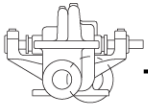

## SAFETY CONSIDERATIONS

The American-Marsh HH multistage split case pump has been designed and manufactured for safe operation. In order to ensure safe operation, it is very important that this manual be read in its entirety prior to installing or operating the pump. American-Marsh Pumps shall not be liable for physical injury, damage or delays caused by a failure to observe the instructions for installation, operation and maintenance contained in this manual.

Remember that every pump has the potential to be dangerous, because of the following factors:

- parts are rotating at high speeds
- high pressures may be present
- high temperatures may be present
- highly corrosive and/or toxic chemicals may be present

Paying constant attention to safety is always extremely important. However, there are often situations that require special attention. These situations are indicated throughout this book by the following symbols:



**DANGER** - Immediate hazards which WILL result in severe personal injury or death.



**WARNING** – Hazards or unsafe practices which COULD result in severe personal injury or death.



**CAUTION** – Hazards or unsafe practices which COULD result in minor personal injury or product or property damage.

Maximum Lifting Speed: 15 feet/second.

If in a climate where the fluid in the casing could freeze, never leave liquid in the pump casing. Drain the casing completely. During winter months and cold weather, the liquid could freeze and damage the pump casing.  
ENGINEERED PROCESS GROUP

Do not run the equipment dry or start the pump without the proper prime (casing flooded).

Never operate the pump for more than a short interval with the discharge valve closed. The length of the interval depends on several factors including the nature of the fluid pumped and its temperature. Contact American-Marsh Engineering for additional support if required.

Never operate the pump with a closed suction valve.

Excessive pump noise or vibration may indicate a dangerous operating condition. The pump must be shutdown immediately.

Do not operate the pump for an extended period of time below the recommended minimum flow. See Figure 7, page 15.

The pump shaft MUST turn toward the suction of the pump when viewed from the motor end. It is absolutely essential that the rotation of the motor be checked before installation of the coupling spacer and starting the pump. Incorrect rotation of the pump for even a short period of time can unscrew the shaft sleeves, which can cause severe damage.

If the liquid is hazardous, take all necessary precautions to avoid damage and injury before emptying the pump casing.

Residual liquid may be found in the pump casing, head and suction line. Take the necessary precautions if the liquid is hazardous, flammable, corrosive, poisonous, infected, etc.

Always lockout power to the driver before performing pump maintenance.

Never operate the pump without the coupling guard and all other safety devices correctly installed.

Do not apply heat to disassemble the pump or to remove the impeller. Entrapped liquid could cause an explosion.

If any external leaks are found while pumping hazardous product, immediately stop operations and repair.

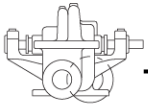

## PUMP IDENTIFICATION

### MANUFACTURER

American-Marsh Pumps  
185 Progress Road  
Collierville, TN 38017  
United States of America

### TYPE OF PUMP

The American-Marsh HH multistage split case pump is a horizontal, two stage, axially split centrifugal pump.

### NAMEPLATE INFORMATION

### DATE OF MANUFACTURE

The date of manufacture is indicated on the pump data plate.

### INSTALLATION, OPERATION & MAINTENANCE MANUAL IDENTIFICATION

Prepared: March, 2005  
Revision:

Edition: 01  
Date of Revision:

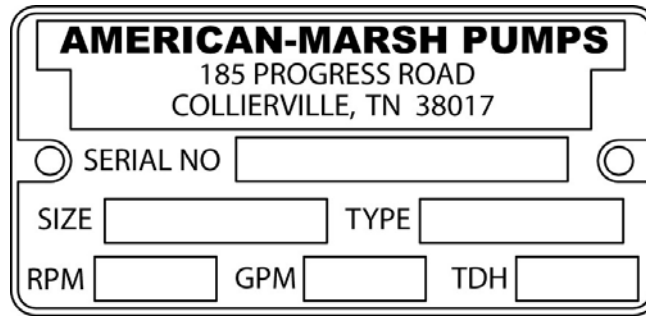
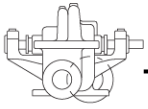

FIGURE 1 – Pump Data Plate

- SERIAL NUMBER : Serial Number of pump unit (issued by Production Control).
- SIZE : Size designation of pump (1.5x2.5-8)
- TYPE : Pump type (HH).
- RPM : Speed of pump.
- GPM : Rated capacity of pump.
- TDH : Rated Total Dynamic Head of pump.



In case of doubt, contact the manufacturer.

## WARRANTY

American-Marsh Pumps guarantees that only high quality materials are used in the construction of our pumps and that machining and assembly are carried out to high standards.

The pumps are guaranteed against defective materials and/or faulty craftsmanship for a period of one year from the date of shipment unless specifically stated otherwise.

Replacement of parts or of the pump itself can only be carried out after careful examination of the pump by qualified personnel.

**The warranty is not valid if third parties have tampered with the pump.**

This warranty does not cover parts subject to deterioration or wear and tear (mechanical seals, pressure and vacuum gauges, rubber or plastic items, bearings, etc.) or damage caused by misuse or improper handling of the pump by the end user.

Parts replaced under warranty become the property of American-Marsh Pumps.

Contact the American-Marsh Pumps' factory:

**American-Marsh Pumps**  
185 Progress Road  
Collierville, TN 38017  
United States Of America

**Phone:** (901) 860-2300  
**Fax:** (901) 860-2323  
**www.american-marsh.com**

## GENERAL INSTRUCTIONS

The pump and motor unit must be examined upon arrival to ascertain any damage caused during shipment. If damaged immediately notify the carrier and/or the sender. Check that the goods correspond exactly to the description on the shipping documents and report any differences as soon as possible to the sender. Always quote the pump type and serial number stamped on the data plate.

**The pumps must be used only for applications for which the manufacturers have specified:**

- ❖ **The construction materials**
- ❖ **The operating conditions (flow, pressure, temperature, etc.)**
- ❖ **The field of application**

## HANDLING AND TRANSPORT

### METHOD OF TRANSPORT

The pump must be transported in the horizontal position

### INSTALLATION

During installation and maintenance, all components must be handled and transported securely by using suitable slings. Handling must be carried out by specialized personnel to avoid damage to the pump and persons. The lifting rings attached to various components should be used exclusively to lift the components for which they have been supplied.

 **CAUTION**

**Maximum lifting speed: 15 feet/second**

## STORAGE

### SHORT-TERM STORAGE

Normal packaging is designed to protect the pump during shipment and for dry, indoor storage for up to two months or less. The procedure followed for this short-term storage is summarized below:

Standard Protection for Shipment :

- a. Loose unmounted items, including, but not limited to, oilers, packing, coupling spacers, stilts, and mechanical seals are packaged in a water proof plastic bag and placed under the coupling guard. Larger items are cartoned and metal banded to the base plate. For pumps not mounted on a base plate, the bag and/or carton is placed inside the shipping carton. All parts bags and cartons are identified with the American-Marsh sales order number, the customer purchase order number, and the pump item number (if applicable).
- b. Inner surfaces of the bearing housing, shaft (area through bearing housing), and bearings are coated with Cortec VCI-329 rust inhibitor, or equal.

**Note: Bearing housings are not filled with oil prior to shipment.**

- c. Regreasable bearings are packed with grease (Royal Purple NLGI#2).
- d. After a performance test, if required, the pump is tipped on the suction flange for drainage (some residual water may remain in the casing). Then, internal surfaces of ferrous casings, covers,

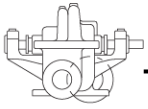

flange faces, and the impeller surface are sprayed with Calgon Vestal Labs RP-743m, or equal. Exposed shafts are taped with Polywrap.

- e. Flange faces are protected with plastic covers secured with plastic drive bolts. 3/16 in (7.8 mm) steel or 1/4 in (6.3 mm) wood covers with rubber gaskets, steel bolts, and nuts are available at extra cost.
- f. All assemblies are bolted to a wood skid which confines the assembly within the perimeter of the skid.
- g. Assemblies with special paint are protected with a plastic wrap.
- h. Bare pumps, when not mounted on base plates, are bolted to wood skids.
- i. All assemblies having external piping (seal flush and cooling water plans), etc. are packaged and braced to withstand normal handling during shipment. In some cases components may be disassembled for shipment. The pump must be stored in a covered, dry location.

### **LONG-TERM STORAGE**

Long-term storage is defined as more than two months, but less than 12 months. The procedure American-Marsh follows for long-term storage of pumps is given below. These procedures are in addition to the short-term procedure.

Solid wood skids are utilized. Holes are drilled in the skid to accommodate the anchor bolt holes in the base plate, or the casing and bearing housing feet holes on assemblies less base plate. Tackwrap sheeting is then placed on top of the skid and the pump assembly is placed on top of the Tackwrap. Metal bolts with washers and rubber bushings are inserted through the skid, the Tackwrap, and the assembly from the bottom of the skid and are then secured with hex nuts. When the nuts are "snugged" down to the top of the base plate or casing and bearing housing feet, the rubber bushing is expanded, sealing the hole from the atmosphere. Desiccant bags are placed on the Tackwrap. The Tackwrap is drawn up around the assembly and hermetically (heat) sealed across the top. The assembly is completely sealed from the atmosphere and the desiccant will absorb any entrapped moisture. A solid wood box is then used to cover the assembly to provide protection from the elements and handling. This packaging will provide protection up to twelve months without damage to mechanical seals, bearings, lip seals, etc. due to humidity, salt laden air, dust, etc. After unpacking, protection will be the responsibility of the user. Addition of oil to the bearing housing will remove the inhibitor. If units are to be idle for extended periods after addition of lubricants, inhibitor oils and greases should be used.

**Every three months, the shaft should be rotated approximately 10 revolutions.**

## **INSTALLATION & ALIGNMENT**

### **FACTORY PRELIMINARY ALIGNMENT PROCEDURE**

The purpose of factory alignment is to ensure that the user will have full utilization of the clearance in the motor holes for final job-site alignment. To achieve this, the factory alignment procedure specifies that the pump be aligned in the horizontal plane to the motor, with the motor foot bolts centered in the motor holes. This procedure ensures that there is sufficient clearance in the motor holes for the customer to field align the motor to the pump, to zero tolerance. This philosophy requires that the customer be able to place the base in the same condition as the factory. Thus the factory alignment will be done with the base sitting in an unrestrained condition on a flat and level surface. This standard also emphasizes the need to ensure the shaft spacing is adequate to accept the specified coupling spacer. The factory alignment procedure is summarized below:

1. The base plate is placed on a flat and level work bench in a free and unstressed position.
2. The base plate is leveled as necessary. Leveling is accomplished by placing shims under the rails (or, feet) of the base at the appropriate anchor bolt hole locations. Levelness is checked in both the longitudinal and lateral directions.
3. The motor and appropriate motor mounting hardware is placed on the base plate and the motor is checked for any planar soft-foot condition. If any is present it is eliminated by shimming.
4. The motor feet holes are centered around the motor mounting fasteners.
5. The motor is fastened in place by tightening the nuts on two diagonal motor mounting studs.
6. The pump is put onto the base plate and leveled. If an adjustment is necessary, we add or delete shims between the pump foot and the base plate.
7. The spacer coupling gap is verified.
8. The parallel and angular *vertical* alignment is made by shimming under the motor.
9. All four motor feet are tightened down.
10. The pump and motor shafts are then aligned *horizontally*, both parallel and angular, by *moving the pump* to the fixed motor. The pump feet are tightened down.

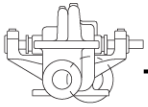

11. Both horizontal and vertical alignment are again final checked as is the coupling spacer gap.

### **RECOMMENDED PROCEDURE FOR BASE PLATE INSTALLATION & FINAL FIELD ALIGNMENT**

#### **NEW GROUTED BASE PLATES**

1. The pump foundation should be located as close to the source of the fluid to be pumped as practical. There should be adequate space for workers to install, operate, and maintain the pump. The foundation should be sufficient to absorb any vibration and should provide a rigid support for the pump and motor. Recommended mass of a concrete foundation should be three times that of the pump, motor and base. Note that foundation bolts are imbedded in the concrete inside a sleeve to allow some movement of the bolt.
2. Level the pump base plate assembly. If the base plate has machined coplanar mounting surfaces, these machined surfaces are to be referenced when leveling the base plate. This may require that the pump and motor be removed from the base plate in order to reference the machined faces. If the base plate is without machined coplanar mounting surfaces, the pump and motor are to be left on the base plate. The proper surfaces to reference when leveling the pump base plate assembly are the pump suction and discharge flanges. **DO NOT** stress the base plate. Do not bolt the suction or discharge flanges of the pump to the piping until the base plate foundation is completely installed. If equipped, use leveling jackscrews to level the base plate. If jackscrews are not provided, shims and wedges should be used. See Figure 2. Check for levelness in both the longitudinal and lateral directions. Shims should be placed at all base anchor bolt locations, and in the middle edge of the base if the base is more than five feet long. Do not rely on the bottom of the base plate to be flat. Standard base plate bottoms are not machined, and it is not likely that the field mounting surface is flat.

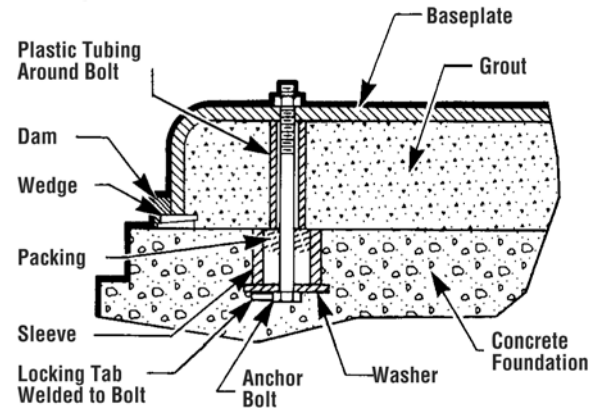

**FIGURE 2 – Base Plate Foundation**

3. After leveling the base plate, tighten the anchor bolts. If shims were used, make sure that the base plate was shimmed near each anchor bolt before tightening. Failure to do this may result in a twist of the base plate, which could make it impossible to obtain final alignment. Check the level of the base plate to make sure that tightening the anchor bolts did not disturb the level of the base plate. If the anchor bolts did change the level, adjust the jackscrews or shims as needed to level the base plate. Continue adjusting the jackscrews or shims and tightening the anchor bolts until the base plate is level.
4. Check initial alignment. If the pump and motor were removed from the base plate proceed with step 5 first, then the pump and motor should be reinstalled onto the base plate using American-Marsh's Factory Preliminary Alignment Procedure, and then continue with the following. As described above, pumps are given a preliminary alignment at the factory. This preliminary alignment is done in a way that ensures that, if the installer duplicates the factory conditions, there will be sufficient clearance between the motor hold down bolts and motor foot holes to move the motor into final alignment. If the pump and motor were properly reinstalled to the base plate or if they were not removed from the base plate and there has been no transit damage, and also if the above steps were done properly, the pump and driver should be within 0.015 in (0.38 mm) FIM (Full Indicator Movement) parallel, and 0.0025 in/in (0.0025 mm/mm) FIM angular. If this is not the case first check to see if the driver mounting fasteners



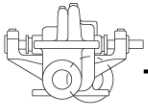

are centered in the driver feet holes. If not, re-center the fasteners and perform a preliminary alignment to the above tolerances by shimming under the motor for vertical alignment, and by moving the pump for horizontal alignment.

5. **Grout the base plate.** A non-shrinking grout should be used. Grout compensates for uneven foundation, distributes weight of unit, and prevents shifting. Use an approved, non-shrinking grout, after setting and leveling unit.
  - a. Build strong form around the foundation to contain grout.
  - b. Soak top of concrete foundation thoroughly, then remove surface water.
  - c. Under pedestal should be completely filled with grout.
  - d. After the grout has thoroughly hardened, check the foundation bolts and tighten if necessary.
  - e. Approximately 14 days after the grout has been poured or when the grout has thoroughly dried, apply an oil base paint to the exposed edges of the grout to prevent air and moisture from coming in contact with the grout.

Make sure that the grout fills the area under the base plate. After the grout has cured, check for voids and repair them.

Jackscrews, shims and wedges should be removed from under the base plate at this time. If they were to be left in place, they could rust, swell, and cause distortion in the base plate.

6. Run piping to the suction and discharge of the pump. There should be no piping loads transmitted to the pump after connection is made. Recheck the alignment to verify that there are no significant loads.
7. Perform final alignment. Check for soft-foot under the driver. An indicator placed on the coupling, reading in the vertical direction, should not indicate more than 0.002 in (0.05 mm) movement when any driver fastener is loosened. Align the driver first in the vertical direction by shimming underneath its feet. When satisfactory alignment is obtained the number of shims in the pack should be minimized. It is recommended that no more than five shims be used under any foot. Final horizontal alignment is made by moving the driver. Maximum pump reliability is obtained by having near perfect alignment. American-Marsh recommends

no more than 0.002 in (0.05mm) parallel, and 0.0005 in/in (0.0005 mm/mm) angular misalignment.

8. Operate the pump for at least an hour or until it reaches final operating temperature. Shut the pump down and recheck alignment while the pump is hot. Piping thermal expansion may change the alignment. Realign pump as necessary.

#### EXISTING GROUDED BASE PLATES

When a pump is being installed on an existing grouted base plate, the procedure is somewhat different from the previous section "New Grouted Base Plates."

1. Mount the pump on the existing base plate.
2. Level the pump by putting a level on the discharge flange. If not level, add or delete shims between the pump foot and the base plate.
3. Check initial alignment. (Step 4 above)
4. Run piping to the suction and discharge flanges of the pump. (Step 6 above)
5. Perform final alignment. (Step 7 above)
6. Recheck alignment after pump is hot. (Step 8 above)

All piping must be independently supported, accurately aligned and preferably connected to the pump by a short length of flexible piping. The pump should not have to support the weight of the pipe or compensate for misalignment. It should be possible to install suction and discharge bolts through mating flanges without pulling or prying either of the flanges. All piping must be tight. Pumps may air-bind if air is allowed to leak into the piping. If the pump flange(s) have tapped holes, select flange fasteners with thread engagement at least equal to the fastener diameter but that do not bottom out in the tapped holes before the joint is tight.

#### **PIPING CONNECTION – SUCTION & DISCHARGE**

When installing the pump piping, be sure to observe the following precautions:

Piping should always be run to the pump. Do not move pump to pipe. This could make final alignment impossible.

Both the suction and discharge piping should be supported independently near the pump and properly aligned, so that no strain is transmitted to the pump when the flange bolts are tightened. Use pipe hangers or other supports at necessary intervals to provide support. When expansion joints are used in the piping system, they must be installed beyond the piping supports closest to the pump. Tie bolts should be used

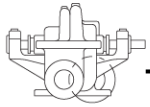

with expansion joints to prevent pipe strain. Do not install expansion joints next to the pump or in any way that would cause a strain on the pump resulting from system pressure changes. It is usually advisable to increase the size of both suction and discharge pipes at the pump connections to decrease the loss of head from friction.

# ! WARNING

**Piping Forces:** Take care during installation and operation to minimize pipe forces and/or moments on the pump casing.

Install piping as straight as possible, avoiding unnecessary bends. Where necessary, use 45-degree or long sweep 90-degree fitting to decrease friction losses.

Make sure that all piping joints are air-tight.

Where flanged joints are used, assure that inside diameters match properly.

Remove burrs and sharp edges when making up joints.

Do not “spring” piping when making any connections.

Provide for pipe expansion when hot fluids are to be pumped.

## SUCTION PIPING

When installing the suction piping, observe the following precautions. See Figure 3.

The sizing and installation of the suction piping is extremely important. It must be selected and installed so that pressure losses are minimized and sufficient liquid will flow into the pump when started and operated. Many NPSH (Net Positive Suction Head) problems can be attributed directly to improper suction piping systems.

Friction losses caused by undersized suction piping can increase the fluid’s velocity into the pump. As recommended by the Hydraulic Institute Standard ANSI/HI 1.1-1.5-1994, suction pipe velocity should not exceed the velocity in the pump suction nozzle. In some situations pipe velocity may need to be further reduced to satisfy pump NPSH requirements and to control suction line losses. Pipe friction can be reduced by using pipes that are one to two sizes larger than the pump

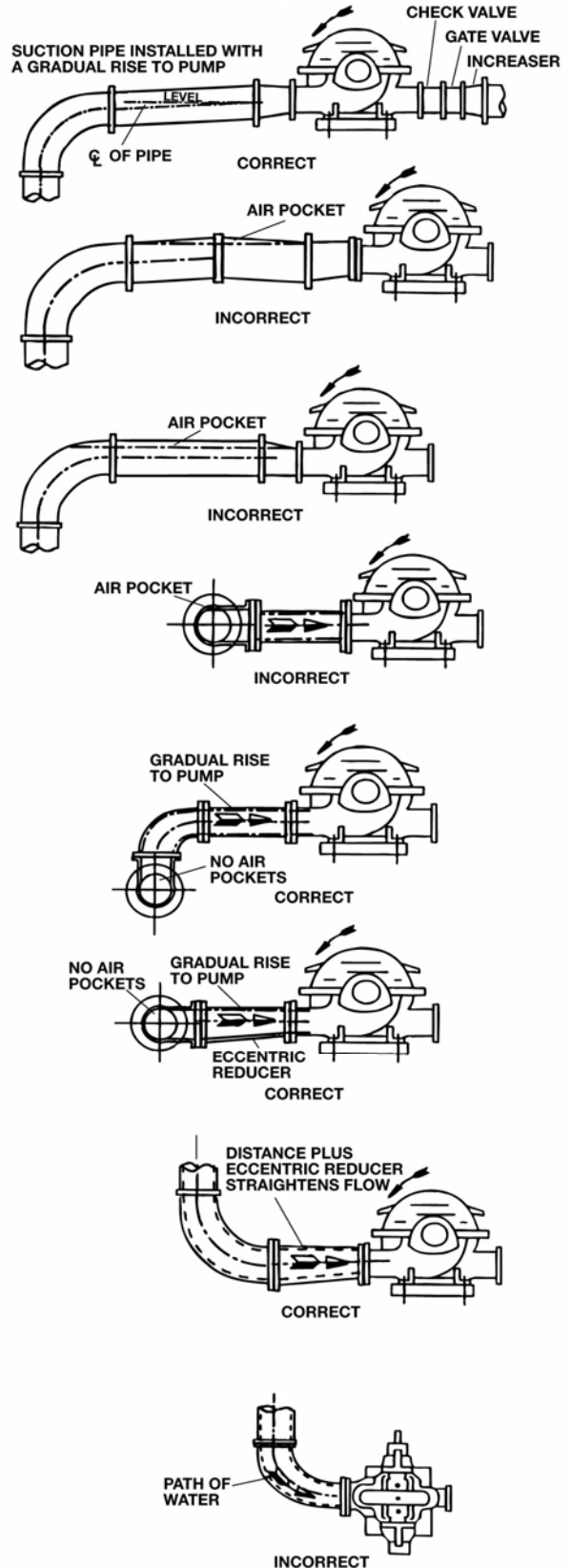

**FIGURE 3 – Good Piping Practices**

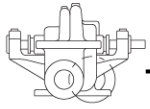

suction nozzle in order to maintain pipe velocities less than 5 feet/second.

Suction piping should be short in length, as direct as possible, and never smaller in diameter than the pump suction opening.

If the suction pipe is short, the pipe diameter can be the same size as the suction opening. If longer suction pipe is required, pipes should be one or two sizes larger than the opening, depending on piping length.

Suction piping for horizontal double suction pumps should not be installed with an elbow close to the suction flange of the pump, except when the suction elbow is in the vertical plane.

A suction pipe of the same size as the suction nozzle, approaching at any angle other than straight up or straight down, must have the elbow located 10 pipe diameters from the suction flange of the pump. Vertical mounted pumps and other space limitations require special piping.

When operating on a suction lift, the suction pipe should slope upward to the pump nozzle. A horizontal suction line must have a gradual rise to the pump. Any high point in the pipe will become filled with air and thus prevent proper operation on the pump. When reducing the piping to the suction opening diameter, use an eccentric reducer with the eccentric side down to avoid air pockets.

**NOTE:** When operating on suction lift, never use a straight taper reducer in a horizontal suction line, as it tends to form an air pocket in the top of the reducer and the pipe.

To facilitate cleaning pump liquid passage without dismantling pump, a short section of pipe (Dutchman or spool piece), so designed that it can be readily dropped out of the line, can be installed adjacent to the suction flange. With this arrangement, any matter clogging the impeller is accessible by removing the nozzle (or pipe section).

### **Valves in Suction Piping**

When installing valves in the suction piping, observe the following precautions:

a. If the pump is operating under static suction lift conditions, a foot valve may be installed in the suction line to avoid the necessity of priming each time the pump is started. This valve should be of the flapper type, rather than the multiple spring type, sized to avoid excessive friction in the suction line. (Under all other conditions, a check valve, if used, should be installed in

the discharge line (See “Valves in Discharge Piping” below).

b. When foot valves are used, or where there are other possibilities of “water hammer,” close the discharge valve slowly before shutting down the pump.

c. Where two or more pumps are connected to the same suction line, install gate valves so that any pump can be isolated from the line. Gate valves should be installed on the suction side of all pumps with a positive pressure for maintenance purposes. Install gate valves with stems horizontal to avoid air pockets. Globe valves should not be used, particularly where NPSH is critical.

d. The pump must never be throttled by the use of a valve on the suction side of the pump. Suction valves should be used only to isolate the pump for maintenance purposes, and should always be installed in positions to avoid air pockets.

e. A pump drain valve should be installed in the suction piping between the isolation valve and the pump.

### **Discharge Piping**

If the discharge piping is short, the pipe diameter can be the same as the discharge opening. If the piping is long, pipe diameter should be one or two sizes larger than the discharge opening. On long horizontal runs, it is desirable to maintain as even a grade as possible. Avoid high spots, such as loops, which will collect air and throttle the system or lead to erratic pumping.

### **Valves in Discharge Piping**

A triple duty valve should be installed in the discharge. The triple duty valve placed on the pump protects the pump from excessive back pressure, and prevents liquid from running back through the pump in case of power failure.

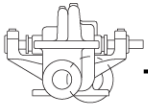

## **! WARNING**

*When fluid velocity in the pipe is high, for example, 10 ft/s (3 m/s) or higher, a rapidly closing discharge valve can cause a damaging pressure surge. A dampening arrangement should be provided in the piping.*

### **Pressure Gauges**

Properly sized pressure gauges should be installed in both the suction and discharge nozzles in the gauge taps (which are provided on request). The gauges will enable the operator to easily observe the operation of the pump, and also determine if the pump is operating in conformance with the performance curve. If cavitation, vapor binding, or other unstable operation should occur, widely fluctuating discharge pressure will be noted.

### **Pump Insulation**

On chilled water applications most pumps are insulated. As part of this practice, the pump bearing housings should not be insulated since this would tend to “trap” heat inside the housing.

This could lead to increased bearing temperatures and premature bearing failures.

### **PUMP AND SHAFT ALIGNMENT CHECK**

After connecting piping, rotate the pump drive shaft clockwise (view from motor end) by hand several complete revolutions to be sure there is no binding and that all parts are free. Recheck shaft alignment. If piping caused unit to be out of alignment, correct piping to relieve strain on the pump.

### **MECHANICAL SEAL**

When the pump is intended to be equipped with a mechanical seal, it is American-Marsh’s standard practice to install the mechanical seal in the pump prior to shipment. Specific order requirements may specify that the seal be shipped separately, or none be supplied. It is the pump installer’s responsibility to determine if a seal was installed. If a seal was supplied but not installed, the seal and installation instructions will be shipped with the pump.

## **! WARNING**

*Failure to ensure that a seal is installed may result in serious leakage of the pumped fluid.*

Seal and seal support system must be installed and operational as specified by the seal manufacturer.

Mechanical seals are preferred over packing on some applications because of better sealing qualities and longer service-ability.

Leakage is eliminated when a seal is properly installed, and normal life is much greater than that of packing on similar applications.

Pumps containing single mechanical seals normally utilize the pumped liquid to lubricate the seal faces. This method is preferred when the pumped liquid is neither abrasive nor corrosive.

### **PACKING**

When the pump is intended to be equipped with shaft packing, it is not American-Marsh’s standard practice to install the packing in the stuffing box prior to shipment. The packing is shipped with the pump. It is the pump installer’s responsibility to install the packing in the stuffing box.

## **! WARNING**

*Failure to ensure that packing is installed may result in serious leakage of the pumped fluid.*

### **PIPING CONNECTION –SEAL/PACKING SUPPORT SYSTEM**

## **! WARNING**

*If the pump has a seal support system, it is mandatory that this system be fully installed and operational before the pump is started.*

If packing is used:

**Packing Lubrication** – Water, when compatible with the pumpage, should be introduced into the packing box at pressure 10 to 15 lbf/in<sup>2</sup> (69 to 103 kPa) above the stuffing box pressure.

The gland should be adjusted to give a flow rate of 20 to 30 drops per minute for clean fluid. For abrasive applications, the regulated flow rate should be 1-2 gpm (0.06-0.13 l/s).

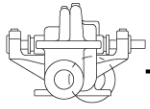

Grease lubrication, when compatible with the pumpage, may be used. In non-abrasive applications the pumpage itself may be sufficient to lubricate the packing without need for external lines. The internal flush line should be plugged.

**Abrasive Packing Arrangement** – The installation procedures are the same as the standard packing with some exceptions. A special lip seal is installed first, followed by two lantern ring assemblies, then two of the packing rings provided.

A flush line from a clean external source should be connected to the top of the stuffing box.

### BEARING LUBRICATION

Grease lubricated ball bearings are packed with grease at the factory and ordinarily will require no attention before starting, provided the pump has been stored in a clean, dry place prior to its first operation. The bearings should be watched the first hour or so after the pump has been started to see that they are operating properly. See Figure 4 for recommended lubricants. Do not allow the bearings to exceed temperatures listed in Figure 5.

Oil lubricated pumps are shipped from the factory without oil in the bearing housings. Before the pump is started the oil reservoirs must be filled with a high quality ISO 100 grade oil with anti-wear additives. The oil should be drained and replaced every 3 to 6 months depending on operating conditions as shown in Figure 6.

The importance of proper lubrication cannot be over emphasized. It is difficult to say how often a bearing should be greased, since that depends on the conditions of operation. It is well to add one ounce of grease at regular intervals, but it is equally important to avoid adding too much grease. For average operating conditions, it is recommended that 1 oz. of grease be added at intervals of three to six months, and only clean grease be used. It is always best if unit can be stopped while grease is added to avoid overloading.

**! CAUTION**

*Excess grease is the most common cause of overheating.*

A lithium based NLGI-2 grade grease should be used for lubricating bearings where the ambient temperature is above -20°F. Grease lubricated bearings are packed at the factory with Royal Purple NLGI #2. Other recommended greases are Texaco Multifak 2, Shell Alvania 2 and Mobilux No. 2 grease. Greases made

from animal or vegetable oils are not recommended due to the danger of deterioration and forming of acid. Do not use graphite. Use of an ISO VG 100 mineral base oil with rust and oxidation inhibitors is recommended. The maximum desirable operating temperature for ball bearings is 180°F. Should the temperature of the bearing frame rise above 180°F, the pump should be shut down to determine the cause.

<b>Mineral Oil</b>	Quality mineral oil with rust and oxidation inhibitors. Mobil DTE Heavy/Medium ISO VG 68 or equivalent.
<b>Synthetic</b>	Royal Purple SynFilm 68, Conoco SYNCON 68 or equivalent. Some synthetic lubricants require Viton O-rings.
<b>Grease</b>	Royal Purple NLGI #2, Chevron SRI #2 (or compatible)

FIGURE 4 – Recommended Lubricants

Maximum Oil Temperature	ISO Viscosity Grade	Minimum Viscosity Index
Up to 160°F (71°C)	46	95
160-175°F (71°-80°C)	68	95
175-200°F (80°-94°C)	100	95

FIGURE 5 – Oil Viscosity Grades

Lubricant	Under 160°F (71°C)	160-175°F (71-80°C)	175-200°F (80-94°C)
Grease	6 mo	3 mo	1.5 mo
Mineral Oil	6 mo	3 mo	1.5 mo
Synthetic Oil**	18 mo	18 mo	18 mo

FIGURE 6 – Re-lubrication Intervals

### COUPLING

A direction arrow is cast on the casing. Make sure the motor rotates in the same direction before coupling the motor to the Pump.

**! CAUTION**

*It is absolutely essential that the rotation of the motor be checked before connecting the shaft coupling. Incorrect rotation of the pump, for even a short time, can dislodge the shaft sleeves which may cause serious damage to the pump.*

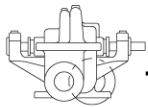

The coupling should be installed as advised by the coupling manufacturer. Pumps are shipped without the spacer installed. If the spacer has been installed to facilitate alignment, then it must be removed prior to checking rotation. Remove protective material from the coupling and any exposed portions of the shaft before installing the coupling.

## PUMP OPERATION

### ROTATION CHECK

# ⚠ CAUTION

*It is absolutely essential that the rotation of the motor be checked before connecting the shaft coupling. Incorrect rotation of the pump, for even a short time, can dislodge and damage the shaft sleeves, impeller, casing, shaft and shaft seal.*

HH pumps can turn clockwise or counter-clockwise and therefore rotation must be specified at time of order.

### PRE START-UP CHECKS

Prior to starting the pump it is essential that the following checks are made. These checks are all described in detail in the Maintenance Section of this booklet.

- Pump and Motor properly secured to the base plate
- Check alignment of pump and motor
- Coupling guard in place and not rubbing
- Rotation check, see above
- THIS IS ABSOLUTELY ESSENTIAL.**
- Shaft seal and/or packing properly installed
- Seal support system operational
- Bearing lubrication
- Pump instrumentation is operational
- Pump is primed
- Rotation of shaft by hand

As a final step in preparation for operation, it is important to rotate the shaft by hand to be certain that all rotating parts move freely, and that there are no foreign objects in the pump.

### PRIMING

If the pump is installed with a positive head on the suction, it can be primed by opening the suction and vent valve and allowing the liquid to enter the casing. If the pump is installed with a suction lift, priming must be

done by other methods such as foot valves, ejectors, or by manually filling the casing and suction line.

### ENSURING PROPER NPSH<sub>A</sub>

Net Positive Suction Head – Available (NPSH<sub>A</sub>) is the measure of the energy in a liquid above the vapor pressure. It is used to determine the likelihood that a fluid will vaporize in the pump. It is critical because a centrifugal pump is designed to pump a liquid, not a vapor. Vaporization in a pump will result in damage to the pump, deterioration of the Total Differential Head (TDH), and possibly a complete stopping of pumping. Net Positive Suction Head – Required (NPSH<sub>R</sub>) is the decrease of fluid energy between the inlet of the pump, and the point of lowest pressure in the pump. This decrease occurs because of friction losses and fluid accelerations in the inlet region of the pump, and particularly accelerations as the fluid enters the impeller vanes. The value for NPSH<sub>R</sub> for the specific pump purchased is given in the pump data sheet, and on the pump performance curve.

For a pump to operate properly the NPSH<sub>A</sub> must be greater than the NPSH<sub>R</sub>. Good practice dictates that this margin should be at least 5 ft (1.5 m) or 20%, whichever is greater.

# ⚠ CAUTION

*Ensuring that NPSH<sub>A</sub> is larger than NPSH<sub>R</sub> by the suggested margin will greatly enhance pump performance and reliability. It will also reduce the likelihood of cavitation, which can severely damage the pump.*

### MINIMUM FLOW

Minimum continuous stable flow is the lowest flow at which the pump can operate and still conform to the bearing life, shaft deflection and bearing housing vibration limits of the ASME standard. Pumps may be operated at lower flows, but it must be recognized that the pump may not conform to one or more of these limits. For example, vibration may exceed the limit set by the ASME standard. The size of the pump, the energy absorbed, and the liquid pumped are some of the considerations in determining the minimum flow.

Typically, limitations of 20% of the capacity at the best efficiency point (BEP) should be specified as the minimum flow. However, American-Marsh has determined that several pumps must be limited to higher minimum flows to provide optimum service. The following are the recommended minimum flows for these specific pumps:

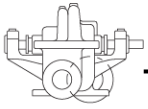

Pump Size	60 Hz		50 Hz	
	RPM	Minimum Flow (% of BEP)	RPM	Minimum Flow (% of BEP)
1.5x2.5-8 1.5x2.5-10 2x3-8 2x3-10 2.5x3-9	3500	30%	2900	25%
3x4-9 3x4-11 4x5-11	3500	25%	2900	21%

**FIGURE 7 – Minimum Continuous Safe Flow**

**Note:** “Minimum intermittent flow” value of 50% of the “minimum continuous flow” as long as that flow is greater than the “minimum thermal flow.”

All HH pumps also have a “Minimum Thermal Flow.” This is defined as the minimum flow that will not cause an excessive temperature rise. Minimum Thermal Flow is application dependent.



*Do not operate the pump below Minimum Thermal Flow, as this could cause an excessive temperature rise. Contact an American-Marsh Sales Engineer for determination of Minimum Thermal flow.*

**STARTING THE PUMP AND ADJUSTING FLOW**

1. Open the suction valve to full open position. It is very important to leave the suction valve open while the pump is operating. Any throttling or adjusting of flow must be done through the discharge valve. Partially closing the suction valve can create serious NPSH and pump performance problems.



*Never operate pump with both the suction and discharge valves closed. This could cause an explosion.*

2. A standard centrifugal pump will not move liquid unless the pump is primed. A pump is said to be “primed” when the casing and the suction piping are completely filled with liquid. Open discharge

valve a slight amount. This will allow any entrapped air to escape and will normally allow the pump to prime, if the suction source is above the pump. When a condition exists where the suction pressure may drop below the pump’s capability, it is advisable to add a low pressure control device to shut the pump down when the pressure drops below a predetermined minimum.

3. All cooling, heating, and flush lines must be started and regulated.
4. Start the driver (typically, the electric motor).
5. Slowly open the discharge valve until the desired flow is reached, keeping in mind the minimum flow restrictions listed above.



*It is important that the discharge valve be opened within a short interval after starting the driver. Failure to do this could cause a dangerous build up of heat, and possibly an explosion.*

6. **Reduced capacity**  
Avoid running a centrifugal pump at drastically reduced capacities or with discharge valve closed for extended periods of time. This can cause severe temperature rise and the liquid in the pump may reach its boiling point. If this occurs, the mechanical seal will be exposed to vapor, with no lubrication, and may score or seize to the stationary parts. Continued running under these conditions when the suction valve is also closed, can create an explosive condition due to the confined vapor at high pressure and temperature. Thermostats may be used to safeguard against over heating by shutting down the pump at a predetermined temperature.

Safeguards should also be taken against possible operation with a closed discharge valve, such as installing a bypass back to the suction source. The size of the bypass line and the required bypass flow rate is a function of the input horsepower and the allowable temperature rise.

7. **Reduced Head**  
Note that when discharge head drops, the pump’s flow rate usually increases rapidly. Check motor for temperature rise as this may cause overload. If overloading occurs, throttle the discharge.
8. **Surging Condition**

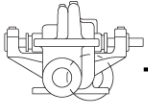

A rapidly closing discharge valve can cause a damaging pressure surge. A dampening arrangement should be provided in the piping.

### ***OPERATION IN SUB-FREEZING CONDITIONS***

When using the pump in sub-freezing conditions where the pump is periodically idle, the pump should be properly drained or protected with thermal devices which will keep the liquid in the pump from freezing. High chrome iron pumps are not recommended for applications below 0°F (-18°C).

### ***SHUTDOWN CONSIDERATIONS***

When the pump is being shutdown, the procedure should be the reverse of the start-up procedure. First, slowly close the discharge valve, shutdown the driver, then close the suction valve. Remember, closing the suction valve while the pump is running is a safety hazard and could seriously damage the pump and other equipment.

### ***TROUBLESHOOTING***

The following is a guide to troubleshooting problems with American-Marsh pumps. Common problems are analyzed and solutions are offered. Obviously, it is impossible to cover every possible scenario. If a problem exists that is not covered by one of the examples, then contact a local American-Marsh Sales Engineer or Distributor/Representative for assistance.



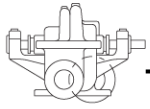

<b>PROBLEM</b>	<b>POSSIBLE CAUSE</b>	<b>RECOMMENDED REMEDY</b>
<b>Problem #1</b> Pump not reaching design flow rate.	1.1 Insufficient NPSH <sub>A</sub> . (Noise may not be present)	Recalculate NPSH available. It must be greater than the NPSH required by pump at desired flow. If not, redesign suction piping, holding number of elbows and number of planes to a minimum to avoid adverse flow rotation as it approaches the impeller.
	1.2 System head greater than anticipated.	Reduce system head by increasing pipe size and/ than or reducing number of fittings. Increase impeller diameter. NOTE: Increasing impeller diameter may require use of a larger motor.
	1.3 Entrained air. Air leak from atmosphere on suction side.	1. Check suction line gaskets and threads for tightness. 2. If vortex formation is observed in suction tank, install vortex breaker. 3. Check for minimum submergence.
	1.4 Entrained gas from process.	Process generated gases may require larger pumps.
	1.5 Speed too low.	Check motor speed against design speed.
	1.6 Direction of rotation wrong.	After confirming wrong rotation, reverse any two of three leads on a three phase motor. The pump should be disassembled and inspected before it is restarted.
	1.7 Impeller too small.	Replace with proper diameter impeller. NOTE: Increasing impeller diameter may require use of a larger motor.
	1.8 Impeller clearance too large.	Replace impeller and/or case wear rings.
	1.9 Plugged impeller, suction line or casing which may be due to a product or large solids.	1. Reduce length of fiber when possible. 2. Reduce solids in the process fluid when possible. 3. Consider larger pump.
	1.10 Wet end parts (casing, impeller) worn, corroded or missing.	Replace part or parts.
<b>Problem #2.0</b> Pump not reaching design head (TDH).	2.1 Refer to possible causes under Problem #1.0.	Refer to remedies listed under Problem #1.0 and #3.0.
<b>Problem #3.0</b> No discharge or flow	3.1 Not properly primed.	Repeat priming operation, recheck instructions. If pump has run dry, disassemble and inspect the pump before operation.
	3.2 Direction of rotation wrong.	After confirming wrong rotation, reverse any two of three leads on a three phase motor. The pump should be disassembled and inspected before operation.

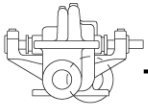

<b>PROBLEM</b>	<b>POSSIBLE CAUSE</b>	<b>RECOMMENDED REMEDY</b>
<b>Cont. Problem #3.0</b> No discharge or flow	3.3 Entrained air. Air leak from atmosphere on suction side.	Refer to recommended remedy under Problem #1.0, Item #1.3.
	3.4 Plugged impeller, suction line or casing which may be due to a fibrous product or large solids.	Refer to recommended remedy under Problem #1.0, Item #1.9.
	3.5 Damaged pump shaft, impeller.	Replace damaged parts.
<b>Problem #4.0</b> Pump operates for short period, then loses prime.	4.1 Insufficient NPSH.	Refer to recommended remedy under Problem #1.0, Item #1.1.
	4.2 Entrained air. Air leak from atmosphere on suction side.	Refer to recommended remedy under Problem #1.0, Item #1.3.
<b>Problem #5.0</b> Excessive noise from wet end.	5.1 Cavitation - insufficient NPSH available.	Refer to recommended remedy under Problem #1.0, Item #1.1.
	5.2 Abnormal fluid rotation due to complex suction piping.	Redesign suction piping, holder number of elbows and number of planes to a minimum to avoid adverse fluid rotation as it approaches the impeller.
	5.3 Impeller rubbing.	1. Replace impeller and/or case wear rings. 2. Check outboard bearing assembly for axial end play.
<b>Problem #6.0</b> Excessive noise from bearings.	6.1 Bearing contamination appearing on the raceways as scoring, pitting, scratching, or rusting caused by adverse environment and entrance of abrasive contaminants from atmosphere.	1. Work with clean tools in clean surroundings. 2. Remove all outside dirt from housing before exposing bearings. 3. Handle with clean dry hands. 4. Treat a used bearing as carefully as a new one. 5. Use clean solvent and flushing oil. 6. Protect disassembled bearing from dirt and moisture. 7. Keep bearings wrapped in paper or clean cloth while not in use. 8. Clean inside of housing before replacing bearings. 9. Check oil seals and replace as required. 10. Check all plugs and tapped openings to make sure that they are tight.
	6.2 Brinelling of bearing identified by indentation on the ball races, usually caused by incorrectly applied forces in assembling the bearing or by shock loading such as hitting the bearing or drive shaft with a hammer.	When mounting the bearing on the outboard end use a proper size ring and apply the pressure against the inner ring only. Be sure when mounting a bearing to apply the mounting pressure slowly and evenly.

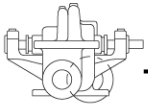

<b>PROBLEM</b>	<b>POSSIBLE CAUSE</b>	<b>RECOMMENDED REMEDY</b>
<b>Cont. Problem #6.0</b> Excessive noise from power end.	6.3 False brinelling of bearing identified again by either axial or circumferential indentations usually caused by vibration of the balls between the races in a stationary bearing.	1. Correct the source of vibration. 2. Where bearings are oil lubricated and employed in units that may be out of service for extended periods, the drive shaft should be turned over periodically to re-lubricate all bearing surfaces at intervals of one-to three months.
	6.4 Thrust overload on bearing identified by flaking ball path on one side of the outer race or in the case of maximum capacity bearings, may appear as a spalling of the races in the vicinity of the loading slot. (Please note: maximum capacity bearings are not recommended in HH pumps.) These thrust failures are caused by improper mounting of the bearing or excessive thrust loads.	1. Follow correct mounting procedures for bearings.
	6.5 Misalignment identified by fracture of ball retainer or a wide ball path on the inner race and a narrower cocked ball path on the outer race. Misalignment is caused by poor mounting practices or defective drive shaft. For example bearing not square with the centerline or possibly a bent shaft due to improper handling.	Handle parts carefully and follow recommended mounting procedures. Check all parts for proper fit and alignment.
	6.6 Bearing damaged by electric arcing identified as electro-etching of both inner and outer ring as a pitting or cratering. Electrical arcing is caused by a static electrical charge emanating from belt drives, electrical leakage or short circuiting.	1. Where current shunting through the bearing cannot be corrected, a shunt in the form of a slip ring assembly should be incorporated. 2. Check all wiring, insulation and rotor windings to be sure that they are sound and all connections are properly made. 3. Where pumps are belt driven, consider the elimination of static charges by proper grounding or consider belt material that is less generative.

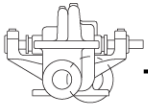

<b>PROBLEM</b>	<b>POSSIBLE CAUSE</b>	<b>RECOMMENDED REMEDY</b>
Cont.: <b>Problem #6.0</b> Excessive noise from power end.	6.7 Bearing damage due to improper lubrication, identified by one or more of the following: 1. Abnormal bearing temperature rise. 2. A stiff cracked grease appearance. 3. A brown or bluish discoloration of the bearing races.	1. Be sure the lubricant is clean. 2. Be sure proper amount of lubricant is used. The constant level oiler supplied with HH pumps will maintain the proper oil level if it is installed and operating properly. In the case of greased lubricated bearings, be sure that there is space adjacent to the bearing into which it can rid itself of excessive lubricant, otherwise the bearing may overheat and fail prematurely. 3. Be sure the proper grade of lubricant is used.

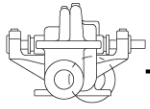

## MAINTENANCE

### PREVENTIVE MAINTENANCE

The following sections of this manual give instructions on how to perform a complete maintenance overhaul. However, it is also important to periodically repeat the "Pre start-up checks" listed on page 14. These checks will help extend pump life as well as the length of time between major overhauls.

### NEED FOR MAINTENANCE RECORDS

A procedure for keeping accurate maintenance records is a critical part of any program to improve pump reliability. There are many variables that can contribute to pump failures. Often long term and repetitive problems can only be solved by analyzing these variables through pump maintenance records.

### NEED FOR CLEANLINESS

One of the major causes of pump failure is the presence of contaminants in the bearing housing. This contamination can be in the form of moisture, dust, dirt and other solid particles such as metal chips. Contamination can also be harmful to the mechanical seal (especially the seal faces) as well as other parts of the pumps. For example, dirt in the shaft threads could cause the impeller to not be seated properly against the shaft sleeve. This, in turn, could cause a series of other problems. For these reasons, it is very important that proper cleanliness be maintained. Some guidelines are listed below.

If it is contaminated, determine the cause and correct. The work area should be clean and free from dust, dirt, oil, grease, etc. Hands and gloves should be clean. Only clean towels, rags, and tools should be used.

### MAINTENANCE OF PUMP DUE TO FLOOD DAMAGE

The servicing of centrifugal pumps after a flooded condition is a comparatively simple matter under normal conditions.

Bearings are a primary concern on pumping units. First, dismantle the bearings; clean and inspect them for any rusted or badly worn surfaces. If bearings are free from rust and wear, re-assemble and re-lubricate them with one of the recommend-ed pump lubricants. Depending on the length of time the pump has remained in the flooded area, it is unlikely that bearing replacement is necessary; however, in the event that rust or worn surfaces appear, it may be necessary to replace the bearings.

Next, inspect the stuffing box, and clean out any foreign matter that might clog the box. Mechanical seals should be cleaned and thoroughly flushed.

Couplings should be dismantled and thoroughly cleaned. Any pump that is properly sealed at all joints and connected to both the suction and discharge should exclude outside liquid. Therefore, it should not be necessary to go beyond the bearings, stuffing box, and coupling when servicing the pump.

ROUTINE MAINTENANCE CHART	
Every Week	Visually check for leaks Check for lubrication Adjust glands as necessary to maintain proper leakage Hand test bearing housing for any sign of temperature rise
Every Month	Check bearing temperature with a thermometer
Every 6 Months	Check the packing and replace if necessary Check alignment of the pump and motor Check holding down bolts for tightness Check coupling for wear
Every Year	Check rotating element for wear Check wear ring clearances Check and regrease bearings Measure total dynamic suction and discharge head

FIGURE 8 – Routine Maintenance Chart

### DISASSEMBLY

Refer to the parts list shown in Figure 20 for item number references used throughout this section.

1. Before performing any maintenance, disconnect the driver from its power supply and lock it off line.



*Lock out power to driver to prevent personal injury.*

2. Close the discharge and suction valves, and drain all liquid from the pump.

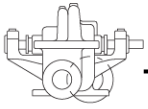

3. Close all valves on auxiliary equipment and piping, then disconnect all auxiliary piping.
4. Decontaminate the pump as necessary. *If American-Marsh pumps contain dangerous chemicals, it is important to follow plant safety guidelines to avoid personal injury or death.*
5. Remove the coupling guard.
6. Remove the spacer coupling and drive key.
7. Drain the pump by removing the vent plug at the top of the casing (#1A).
8. Loosen the gland bolts and washers (#72B) and pull the gland assembly (#71A or #71B) away from the casing (#1A).
9. Remove the fasteners holding the upper casing to the lower casing (#1A). Remove any external piping if supplied.
10. Insert a screwdriver or pry bar into the slots between the upper and lower (#1A) casing halves and separate the halves, lifting off the upper casing half (#1A). Discard the casing gasket (#353A).

## **DANGER**

*The upper casing (#1A) is heavy. It is important to follow plant safety guidelines when lifting it.*

## **WARNING**

*Due to the similarity of parts between the outboard and inboard bearing housings, it is very important to keep the parts separate for proper re-assembly.*

11. Remove the two cap screws (384B) from the outboard and inboard bearing housing straps.
12. Remove the rotating assembly from the casing (#1A).

### PURGE GREASE BEARING HOUSING PORTION OF ROTATING ASSEMBLY

13. Remove the four bearing cap capscrews from the outboard bearing housing cap (#85N). Remove the outboard bearing housing cap (#85N). Discard the outboard bearing housing cap gasket (#353B).
14. Remove the locknut (#89N) and lockwasher (#91N) from the outboard end of the shaft (#41D). Discard the lockwasher (#91D).
15. Using a puller, pull the outboard bearing (#81N) and outboard bearing housing (#82N) from the

- shaft (#41D). Discard the outboard bearing (#81N).
16. Remove the outboard shaft bushing (#45A) from the shaft (#41D).
17. Remove the four bearing cap capscrews from the inboard bearing housing cap (#85P). Remove the inboard bearing housing cap (#85P). Discard the outboard bearing housing cap gasket (#353B).
18. Remove the locknut (#89P) and lockwasher (#91P) from the inboard end of the shaft (#41D). Discard the lockwasher (#91P).
19. Using a puller, pull the inboard bearing (#81P) and inboard bearing housing (#82P) from the shaft (#41D). Discard the inboard bearing (#81P).
20. Remove the inboard shaft bushing (#45A) from the shaft (#41D).

### OPTIONAL RING OILED BEARING HOUSING PORTION OF ROTATING ASSEMBLY

21. Remove the four bearing cap capscrews from the outboard/outboard bearing housing cap (#85N). Remove the outboard/outboard bearing housing cap (#85N). Discard the outboard bearing housing cap gasket (#353B).
22. Remove the locknut (#89N) and lockwasher (#91N) from the outboard end of the shaft (#41D). Discard the lockwasher (#91D).
23. Remove the bearing spacer (#87N) and the oil ring (#88M).
24. Using a puller, pull the outboard bearing (#81N) and outboard bearing housing (#82N) from the shaft (#41D). Discard the outboard bearing (#81N).
25. Remove the four bearing cap capscrews from the outboard/inboard bearing housing cap (#97N). Remove the outboard/inboard bearing housing cap (#85N). Discard the outboard/inboard bearing housing cap gasket (#353B).
26. Remove the outboard shaft bushing (#45A) from the shaft (#41D).
27. Remove the four bearing cap capscrews from the inboard bearing housing cap (#85P). Remove the inboard bearing housing cap (#85P). Discard the outboard bearing housing cap gasket (#353B).
28. Remove the locknut (#89P) and lockwasher (#91P) from the inboard end of the shaft (#41D). Discard the lockwasher (#91P).
29. Remove the bearing spacer (#87N) and the oil ring (#88M).
30. Using a puller, pull the inboard bearing (#81P) and inboard bearing housing (#82P) from the shaft (#41D). Discard the inboard bearing (#81P).

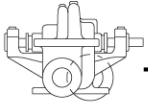

31. Remove the four bearing cap capscrews from the inboard/inboard bearing housing cap (#97N). Remove the inboard/inboard bearing housing cap (#85N). Discard the inboard/inboard bearing housing cap gasket (#353B).
32. Remove the inboard shaft bushing (#45A) from the shaft (#41D).

43. Remove the inboard shaft sleeve (#42C), inspect and replace if necessary. Remove the inboard case wear ring (#15A).
44. Remove the impeller (#11J for right-hand rotation and #11H for left-hand rotation) from the shaft (#41D).
45. Inspect and replace the impeller key (#24A) if required.

#### FLUID PORTION OF ROTATING ASSEMBLY

## **CAUTION**

*Mechanical seal faces can be extremely fragile and brittle in nature. Extreme care should be taken when handling these parts.*

33. If the pump is equipped with a mechanical seal assembly (#331B) at this time remove the gland assembly (#71B) from the outboard and inboard locations of the shaft (#41D). Remove and replace both mechanical seal stationary seats located in the gland assemblies (#331B) if any damage or excessive wear is indicated.
34. Loosen and remove the outboard shaft sleeve nut (#43B) and shaft sleeve o-ring (#331C). Discard the shaft sleeve o-ring (#331C).
35. If the pump is equipped with packing, remove all rings of packing (#331A) and discard. Remove the lantern ring (#73A) if equipped.
36. If the pump is equipped with a mechanical seal (#331B), carefully slide the rotating seal assembly off of the shaft (#41D). Remove and replace the mechanical seal rotary head if any damage or excessive wear is indicated.
37. Remove the outboard shaft sleeve (#42B), inspect and replace if necessary. Remove the outboard case wear ring (#15A).
38. Remove the impeller (#11J for right-hand rotation and #11H for left-hand rotation) from the shaft (#41D).
39. Remove the stage piece (#18B) from the shaft (#41D).
40. Loosen and remove the inboard shaft sleeve nut (#43C) and shaft sleeve o-ring (#331C). Discard the shaft sleeve o-ring (#331C).
41. If the pump is equipped with packing, remove all rings of packing (#331A) and discard. Remove the lantern ring (#73A) if equipped.
42. If the pump is equipped with a mechanical seal (#331B), carefully slide the rotating seal assembly off of the shaft (#41D). Remove and replace the mechanical seal rotary head if any damage or excessive wear is indicated.

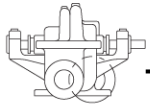

## RE-ASSEMBLY

### BEARING INSTALLATION

Mounting of bearings on shafts must be done in a clean environment. Bearing and power end life can be drastically reduced if even very small foreign particles work their way into the bearings.

Bearings should be removed from their protective packaging only immediately before assembly to limit

exposure to possible contamination. After removing the packaging they should only come in contact with clean hands, fixtures, tools and work surfaces.

The chart shown in Figure 9 gives the SKF part numbers for bearings in American-Marsh HH pumps. Note that the term “inboard bearing” refers to the bearing nearest to the motor. “Outboard bearing” refers to the bearing farthest from the motor.

Pump Model	Type of Bearings	Inboard Single Row, Deep Groove <sup>⑤</sup>	Outboard Single Deep Groove <sup>⑤</sup>
1.5x2.5-8 1.5x2.5-10 2x3-8	Oil bath/mist – Open <sup>①</sup> Regreasable – Single Shielded <sup>②</sup> Greased for life – Double Shielded <sup>③</sup> Sealed for life – Double Sealed <sup>④</sup>	6405-C3 6405-ZC3 6405-2ZC3 6405-2RSIC3	6405-C3 6405-ZC3 6405-2ZC3 6405-2RSIC3
2x3-10 2.5x3-9 3x4-9	Oil bath/mist – Open <sup>①</sup> Regreasable – Single Shielded <sup>②</sup> Greased for life – Double Shielded <sup>③</sup> Sealed for life – Double Sealed <sup>④</sup>	6406-C3 6406-ZC3 6406-2ZC3 6406-2RSIC3	6406-C3 6406-ZC3 6406-2ZC3 6406-2RSIC3
3x4-11	Oil bath/mist – Open <sup>①</sup> Regreasable – Single Shielded <sup>②</sup> Greased for life – Double Shielded <sup>③</sup> Sealed for life – Double Sealed <sup>④</sup>	6407-C3 6407-ZC3 6407-2ZC3 6407-2RSIC3	6407-C3 6407-ZC3 6407-2ZC3 6407-2RSIC3
4x5-11	Oil bath/mist – Open <sup>①</sup> Regreasable – Single Shielded <sup>②</sup> Greased for life – Double Shielded <sup>③</sup> Sealed for life – Double Sealed <sup>④</sup>	6408-C3 6408-ZC3 6408-2ZC3 6408-2RSIC3	6408-C3 6408-ZC3 6408-2ZC3 6408-2RSIC3

**FIGURE 9 – AMP HH Bearings**

①These bearings are open on both sides. They are lubricated by oil bath or oil mist.

②These bearings are pre-greased by American-Marsh. Replacement bearings will generally not be pre-greased, so grease must be applied by the user. They have a single shield, which is located on the side next to the grease buffer, or reservoir. The bearings draw grease from the reservoir as it is needed. The shield protects the bearing from getting too much grease, which would generate heat. The grease reservoir is initially filled with grease by American-Marsh. Lubrication fittings are provided, to allow the customer to periodically replenish the grease, as recommended by the bearing and/or grease manufacturer.

③These bearings are shielded on both sides. They come pre-greased by the bearing manufacturer. The user does not need to re-grease these bearings. The shields do not actually contact the bearing race, so no heat is generated.

④These bearings are sealed on both sides. They come pre-greased by the bearing manufacturer. The user does not need to re-grease these bearings. The seals physically contact and rub against the bearing race, which generates heat. These bearings are not recommended at speeds above 1750 RPM.

⑤The codes shown are SKF codes. Inboard and outboard bearings have the C3, greater than “Normal” clearance. These clearances are recommended by SKF to maximize bearing life.



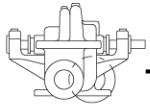

**FLUID PORTION OF ROTATING ASSEMBLY**

1. Wipe over the shaft (#41D) with clean light oil. Place impeller key (#24A) into shaft keyway. Check impellers (#11H & 11J) for correct rotation (See Figure 10) and place the inboard impeller (#11J for right-hand rotation and #11H for left-hand rotation) onto the shaft (#41D). Install the stage piece (#18B) onto the impeller hub.

**CAUTION**

*Be sure that the register on the stage piece is facing the correct direction. If it is not, damage to the casing and/or the stage piece can occur during re-installation of the rotating assembly into the casing.*

2. Install the inboard case wear ring (#15A) onto the impeller (#11J for right-hand rotation and #11H for left-hand rotation). Install the opposite impeller (#11J for right-hand rotation and #11H for left-hand rotation) onto the shaft (#41D). Install the opposite case wear ring (#15A) onto remaining impeller.
3. Slide the outboard shaft sleeve (#42C) onto the shaft (#41D). Lubricate and roll the shaft sleeve o-ring (#331C) onto the shaft (#41D) and install/tighten the outboard shaft sleeve nut (#43C) against the shaft sleeve (#42C).
4. Slide the inboard shaft sleeve (#42C) onto the shaft (#41D). Lubricate and roll the shaft sleeve o-ring (#331C) onto the shaft (#41D) and install/tighten the inboard shaft sleeve nut (#43C) against the shaft sleeve (#42C). Install packing per **INSTALLING STUFFING BOX PACKING** on Page 28.
5. If the pump is equipped with a mechanical seal assembly (#331B) at this time install the gland assembly (#71B) from the outboard and inboard locations of the shaft (#41D). Be sure that the mechanical seal gland gasket is installed.
6. Install the shaft bushings (#45A) on the outboard and inboard locations on the shaft (#41D) until they are seated against the shoulder on the shaft (#41D).

**PURGE GREASE BEARING HOUSING PORTION OF ROTATING ASSEMBLY**

7. Heat the outboard ball bearing (#81N) to approximately 212°F (100°C) using a bearing hot plate or lubricating oil bath.

**WARNING**

*Do not exceed 248°F (120°C). Temperatures in excess of this will permanently damage ball bearing.*

8. Slide the outboard bearing (#81N) into the outboard bearing housing (#82N) until the bearing is seated at the bottom of the bearing housing (#82N).

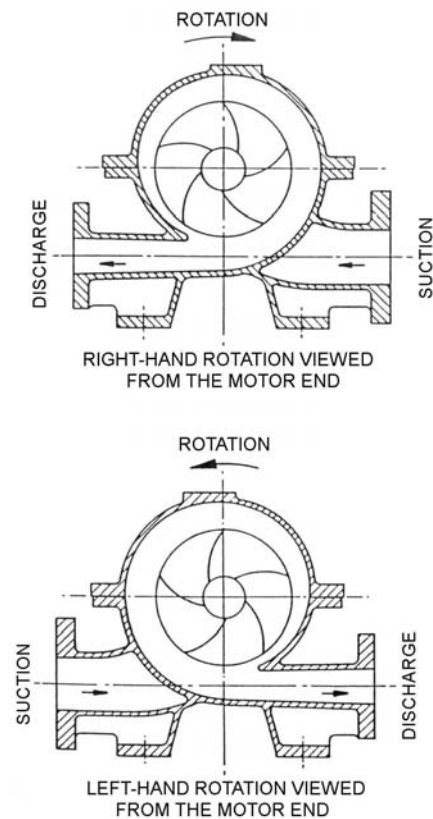

**FIGURE 10 - Proper Impeller Rotation**

9. Heat the outboard ball bearing (#81N) and bearing housing (#82N) to approximately 212°F (100°C) using a bearing hot plate or lubricating oil bath. Slide the bearing housing assembly onto the shaft (#41D) until it is in contact with the shaft bushing (#45A).
10. Cool the bearing to room temperature and coat both sides with two to three ounces of recommended grease.
11. Install the outboard lockwasher (#89N) and outboard locknut (#89N).
12. Install a new outboard bearing housing cap gasket (#353B). Install the outboard bearing housing cap (#85N). Install the four bearing cap

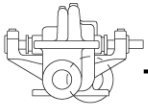

capscrews from the outboard bearing housing cap (#85N) location.

- 13. Heat the inboard ball bearing (#81P) to approximately 212°F (100°C) using a bearing hot plate or lubricating oil bath.

# ! WARNING

*Do not exceed 248°F (120°C). Temperatures in excess of this will permanently damage ball bearing.*

- 14. Slide the inboard bearing (#81P) into the inboard bearing housing (#82P) until the bearing is seated at the bottom of the bearing housing (#82P).
- 15. Heat the inboard ball bearing (#81P) and bearing housing (#82N) to approximately 212°F (100°C) using a bearing hot plate or lubricating oil bath. Slide the bearing housing assembly onto the shaft (#41D) until it is in contact with the shaft bushing (#45A).
- 16. Cool the bearing to room temperature and coat both sides with two to three ounces of recommended grease.
- 17. Install the outboard lockwasher (#89P) and outboard locknut (#89P).
- 18. Install a new outboard bearing housing cap gasket (#353B). Install the outboard bearing housing cap (#85P). Install the four bearing cap capscrews from the outboard bearing housing cap (#85P) location.

## RING OILED BEARING HOUSING PORTION OF ROTATING ASSEMBLY

- 46. Install the outboard/inboard bearing housing cap gasket (#353B) and install the outboard/inboard bearing housing cap (#85N) to the bearing housing. Install the four bearing cap capscrews from the outboard/inboard bearing housing cap (#85N) location.
- 19. Heat the outboard board ball bearing (#81N) to approximately 212°F (100°C) using a bearing hot plate or lubricating oil bath.

# ! WARNING

*Do not exceed 248°F (120°C). Temperatures in excess of this will permanently damage ball bearing.*

- 20. Slide the outboard bearing (#81N) into the outboard bearing housing (#82N) until the

bearing is seated at the bottom of the bearing housing (#8sN).

- 47. Heat the outboard ball bearing (#81N) and bearing housing (#82N) to approximately 212°F (100°C) using a bearing hot plate or lubricating oil bath. Slide the bearing housing assembly onto the shaft (#41D) until it is in contact with the shaft bushing (#45A).
- 48. Cool the bearing to room temperature and coat both sides with two to three ounces of recommended grease.
- 49. Install the bearing spacer (#87N) and the oil ring (#88M).
- 50. Install the outboard lockwasher (#89N) and outboard locknut (#89N).
- 51. Install the outboard/outboard bearing housing cap gasket (#353B) and install the outboard/outboard bearing housing cap (#85N) to the bearing housing. Install the four bearing cap capscrews from the outboard/outboard bearing housing cap (#85N) location.
- 52. Install the inboard/inboard bearing housing cap gasket (#353B) and install the inboard/inboard bearing housing cap (#85P) to the bearing housing. Install the four bearing cap capscrews from the inboard/inboard bearing housing cap (#85P) location.
- 21. Heat the inboard board ball bearing (#81P) to approximately 212°F (100°C) using a bearing hot plate or lubricating oil bath.

# ! WARNING

*Do not exceed 248°F (120°C). Temperatures in excess of this will permanently damage ball bearing.*

- 22. Slide the inboard bearing (#81P) into the inboard bearing housing (#82P) until the bearing is seated at the bottom of the bearing housing.
- 23. Heat the inboard ball bearing (#81N) and bearing housing (#82N) to approximately 212°F (100°C) using a bearing hot plate or lubricating oil bath. Slide the bearing housing assembly onto the shaft (#41D) until it is in contact with the shaft bushing (#45A).
- 24. Cool the bearing to room temperature and coat both sides with two to three ounces of recommended grease.
- 25. Install the bearing spacer (#87P) and the oil ring (#88M).
- 26. Install the inboard lockwasher (#89P) and outboard locknut (#89P).
- 27. Install the inboard/inboard bearing housing cap gasket (#353B) and install the inboard/inboard

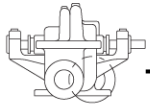

bearing housing cap (#85N) to the bearing housing. Install the four bearing cap capscrews from the inboard/inboard bearing housing cap (#85N) location.

28. Place the casing gaskets (#353A) on the pump casing half (#1A). Pull the gaskets tight against the casing studs (#381B).
29. Set the rotating assembly into the bottom half of the casing (#1A). Align the pins (#16A) for the case wear rings (#16A) and the pin (#16B) for the stage piece (#18B) so the rotor assembly drops down into the lower half of the casing (#1A). Check to make sure the impeller (#11H & 11J) are located in a central position within the casing (#1A) and between the case wear rings (#15A). The rotor assembly should rotate freely at this point. If this is not the case, the binding point must be located and eliminated. Disassembly of the rotor assembly may need to occur. If the impellers (#11H & 11J) are not located properly within the casing (#1A), the shaft sleeves (#42A) may need to be shifted to reorient the impellers (#11H & 11J) (left or right).
30. Lower the upper half of the casing (#1A) into place and install the casing nuts (#381B). Orient the casing top so that the location pins in the bottom of the casing engage with the top of the pump casing.
31. Tighten the four bearing strap capscrews (#381B) over each bearing housing.
32. Insert the four hinge bolt capscrews (#72B) into the milled pockets located on each side of the gland assembly.
33. Tighten the casing nuts (#381B) to the proper torque rating per Figure 11 by crossing the casing back and fourth to ensure a balanced tightening sequence.
34. If the pump is equipped with mechanical seals, tighten and draw up the gland assembly tight to the casing. Do not over-tighten.
35. Install external flush piping, if supplied.
36. Rotate the shaft by hand to assure smooth turning and that it is free from rubbing or binding.

BOLT SIZE		TIGHTENING TORQUE	
Metric	Standard	Lbf ft	Nm
4 mm	5/32"	2.7	3.6
5 mm	3/16"	5.2	7.0
6 mm	1/4"	8.9	12.0
7 mm	9/32"	14.6	19.8
8 mm	5/16"	21.8	29.6
9 mm	11/32"	28.0	38.0
10 mm	3/8"	38.7	52.5
12 mm	1/2"	65.6	89.0
14 mm	9/16"	99.6	135
16 mm	5/8"	151	205
18 mm	11/16"	190	257
20 mm	3/4"	264	358
22 mm	7/8"	321	435
24 mm	15/16"	411	557

**FIGURE 11 – Casing Nut Torque Values**

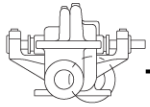

### INSTALLING STUFFING BOX PACKING

Refer to Figure 12 for number of packing rings required by pump model.

If packing is to be cut from a coil or long length:

1. Wrap the packing around a dummy shaft, equal to the shaft sleeve diameter.
2. To assist in cutting rings, two guides lines parallel to the shaft axis and separated by a distance equal to the packing section may be drawn on the spiral.
3. Cut the rings from the spiral at an angle of 45° diagonally across the guide lines. No gap is left between the ends.

Insert the first ring and tap it to the bottom of the stuffing box. Each following ring should be installed in the same manner and positioned in the stuffing box so that the split is advanced 90°.

Install the lantern ring in its proper position to align with the internal flush connection allowing for movement of the ring deeper into the box as the packing is compressed. Standard HH pumps have a lantern ring in the first stage stuffing box only. HH pumps can be furnished with an option second stage lantern ring.

When the correct number of rings have been inserted, the last packing ring should not protrude past the stuffing box face, so that the gland may be properly started in the stuffing box bore.

Bring the gland follower up squarely against the last packing ring and tighten the nuts evenly to finger pressure. Turn the shaft to ensure it does not bind on the bore of the gland assembly.

Pressurize the stuffing box, ensuring air is not trapped. A packed gland must leak and leakage should take place commencing soon after the stuffing box is pressurized.

Until steady leakage takes place, the pump may overheat. If this happens, the pump must be stopped and allowed to cool and, when re-started, leakage should take place. If it does not, this operation should be repeated. Gland nuts (#72C) should not be slackened.

After the pump has been running for ten (10) minutes with steady leakage, tighten the gland nuts (#72C) by one sixth of a full turn. Continue to adjust at ten (10) minutes intervals, each time evenly by one sixth of a full turn, until the leaking is reduced to an acceptable level.

Pump Model	Stuffing Box Information		
	Bore	Depth	Packing
1.5x2.5-8 HH	2.250	2.875	8 - 3/8" SQ
1.5x2.5-10 HH	2.250	2.875	8 - 3/8" SQ
2x3-8 HH	2.250	2.875	8 - 3/8" SQ
2x3-10 HH	2.625	2.875	8 - 7/16" SQ
2.5x3-9 HH	2.625	2.875	8 - 7/16" SQ
3x4-9 HH	2.625	2.875	8 - 7/16" SQ
3x4-11 HH	3.000	3.250	7 - 1/2" SQ
4x5-11 HH	3.375	3.750	8 - 1/2" SQ

FIGURE 12 – Stuffing Box Information



*Excessive gland pressure will cause damage by cutting off lubrication to the packing and packing will burn and damage the shaft sleeve.*

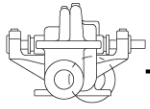

## APPENDIX A

### AMERICAN-MARSH HH MAINTENANCE INSTRUCTIONS BEARING HOUSING OIL SEALS (LABYRINTH TYPE) INPRO/SEAL® VBXX BEARING ISOLATORS

#### INTRODUCTION

American-Marsh Pumps provides pumps fitted with a variety of labyrinth oil seals. While these instructions are written specifically for the Inpro/Seal VBXX labyrinth, they also apply to seals of other manufacturers. Specific installation instructions included with the seal, regardless of manufacturer, should be observed.

The Inpro “VBXX” Bearing Isolator is a labyrinth type seal which isolates the bearings from the environment (uncontaminated), and retains the oil in the bearing housing. The bearing isolator consists of a rotor and a stator. The rotor revolves with the shaft, driven by a close fitted drive ring that rotates with the shaft. The stator is a stationary component that fits into the housing bore with a press fit (nominal 0.002 in (0.05 mm) interference) and with an “O” ring gasket seal. The two pieces are assembled as a single unit, and are axially locked together by an “O” ring. There is no mechanical contact between the rotor and stator when the isolator is running.

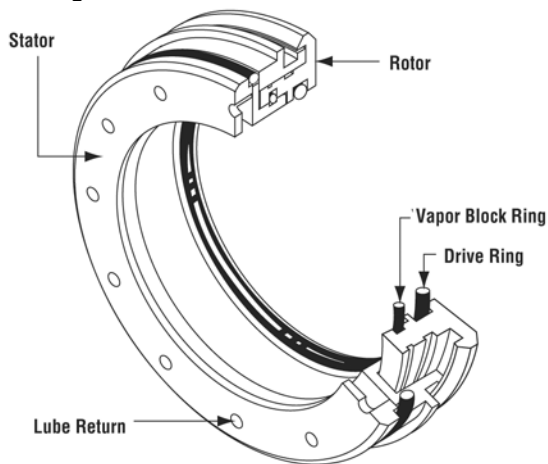

FIGURE 13 – Bearing Isolator

The VBXX is not intended to be separated from the bearing arm unless being replaced.

1. If the VBXX is removed from the housing, for any reason, it must be replaced with a new

- VBXX to ensure a perfect seal with the housing bore.
2. Repair or replacement of the seals is only necessary when excessive oil leakage is evident. However, if for any other reason, the bearing housing is to be disassembled or the pump shaft removed, it is recommended that the rotor “O” rings (which seal on the shaft) be replaced. Spare or replacement “O” rings may be obtained from “Inpro” distributors.

The “Inpro” VBXX bearing isolator is a one piece assembly. The rotor must not pull out of the stator. If the rotor can be removed, the complete seal assembly must be replaced.

3. If the bearing arm with bronze VBXX seals is washed or cleaned using a caustic type bath, the bronze material may discolor (turn black). If this happens, the complete seal assembly must be replaced. **Note:** This may occur if the housing is left in a caustic bath over a long period of time (more than 8 hours).
4. To remove the VBXX bearing isolator:
  - A. Remove the pump shaft as described in the pump disassembly instructions.
  - B. From the inside of the bearing arm (#86N & 86P), place a bar (made from a soft material such as wood or plastic) against the inside face of the seal. Push the seal out by tapping the bar with a soft mallet or an arbor press.
5. To install a new VBXX bearing isolator, in the outboard or inboard bearing arm:
  - A. Position the outboard seal in the bore of the bearing arm (#86N & 86P) with the **single expulsion port at the 6 o’clock position**, (carefully keep aligned with the bore).
  - B. The seal stator O.D. press fits into the bore. Use an arbor press. Place a block or bar (large enough to protect the rotor flange) between the arbor press ram and seal face. Press the seal down into the bore stopping at the shoulder on the stator O.D.

The elastomer “O” ring acts as a gasket to ensure damming up of small imperfections in the housing bore. The “O” ring is designed to be compressed to the point of overfilling its groove. The overfilled material is sheared off during assembly. Remove any sheared “O” ring material which may extrude from the bore.

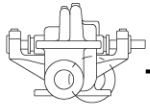

## APPENDIX B

### TRICO OILER INSTRUCTIONS

#### LUBRICATOR RE-INSTALLATION

1. Check the center line of the lubricator and confirm that it is parallel with the bearing housing (Figure 14 & 15). Use spirit level if possible. Should a condition as in Figure 16 occur, the lubricator will not function properly. This condition must be corrected either by re-tapping the bearing housing or by adjusting the pipes.
2. Place the upper part of the lubricator on to the lower part and tighten the three (3) setscrews (Figure 17).
3. Fill the reservoir with oil, place thumb over reservoir spout, invert and screw reservoir inter upper casting. Allow reservoir to empty, filling the bearing housing (Figure 18). Depending on the size and capacity of the bearing housing several fillings of the reservoir may be required before the actual oil level is reached. **NEVER USE THE LOWER CASTING ONLY AS A FILL SPOUT, ALWAYS FILL THROUGH THE RESERVOIR.** When oil level is reached, no more oil will run out of reservoir bottle.

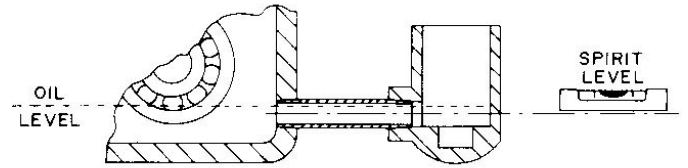

Figure 14

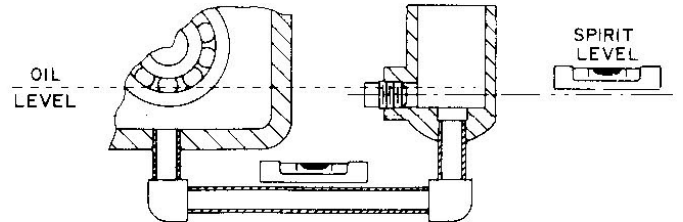

Figure 15

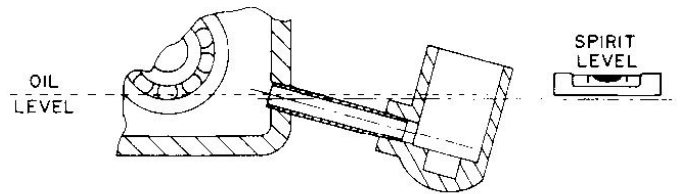

Figure 16

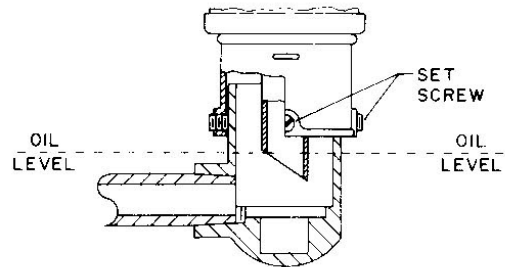

Figure 17

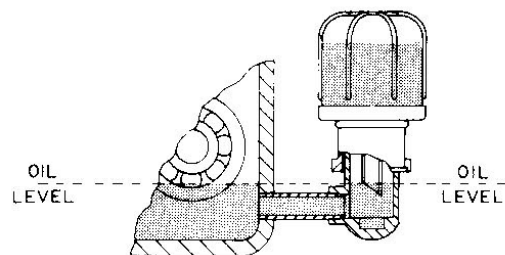

Figure 18

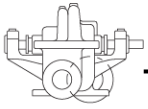
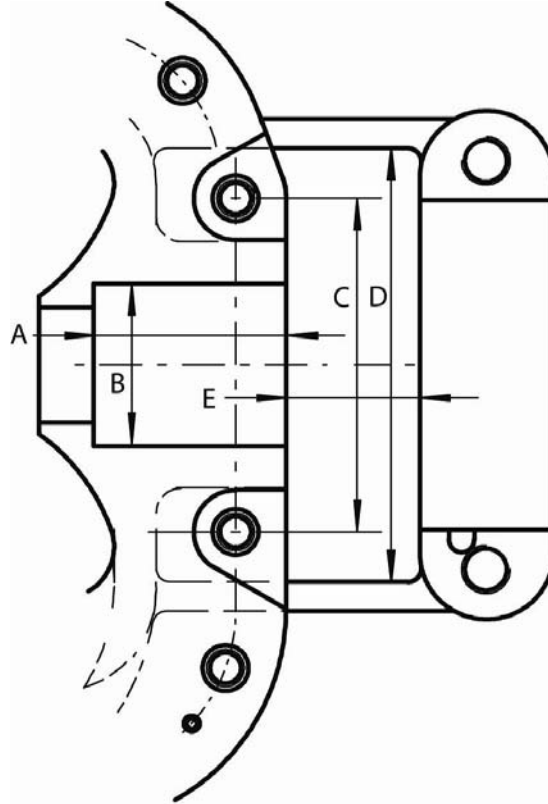

Figure 19 – HH Packing/Seal Chamber Details



Pump Model	Sleeve Diameter	Hinge Bolt Diameter	A	B	C	D	E
1.5x2.5-8 HH	2.250	0.500	2.875	2.250	4.500	RTF	1.813
1.5x2.5-10 HH	2.250	0.500	2.875	2.250	4.500		1.813
2x3-8 HH	2.250	0.500	2.875	2.250	4.500		1.813
2x3-10 HH	2.625	0.500	2.875	2.625	5.000		1.813
2.5x3-9 HH	2.625	0.500	2.875	2.625	4.750		1.813
3x4-9 HH	2.625	0.500	2.875	2.625	4.750		1.813
3x4-11 HH	3.000	0.500	3.250	3.000	5.000		2.313
4x5-11 HH	3.375	0.625	3.750	3.375	6.500		2.250

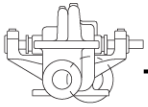
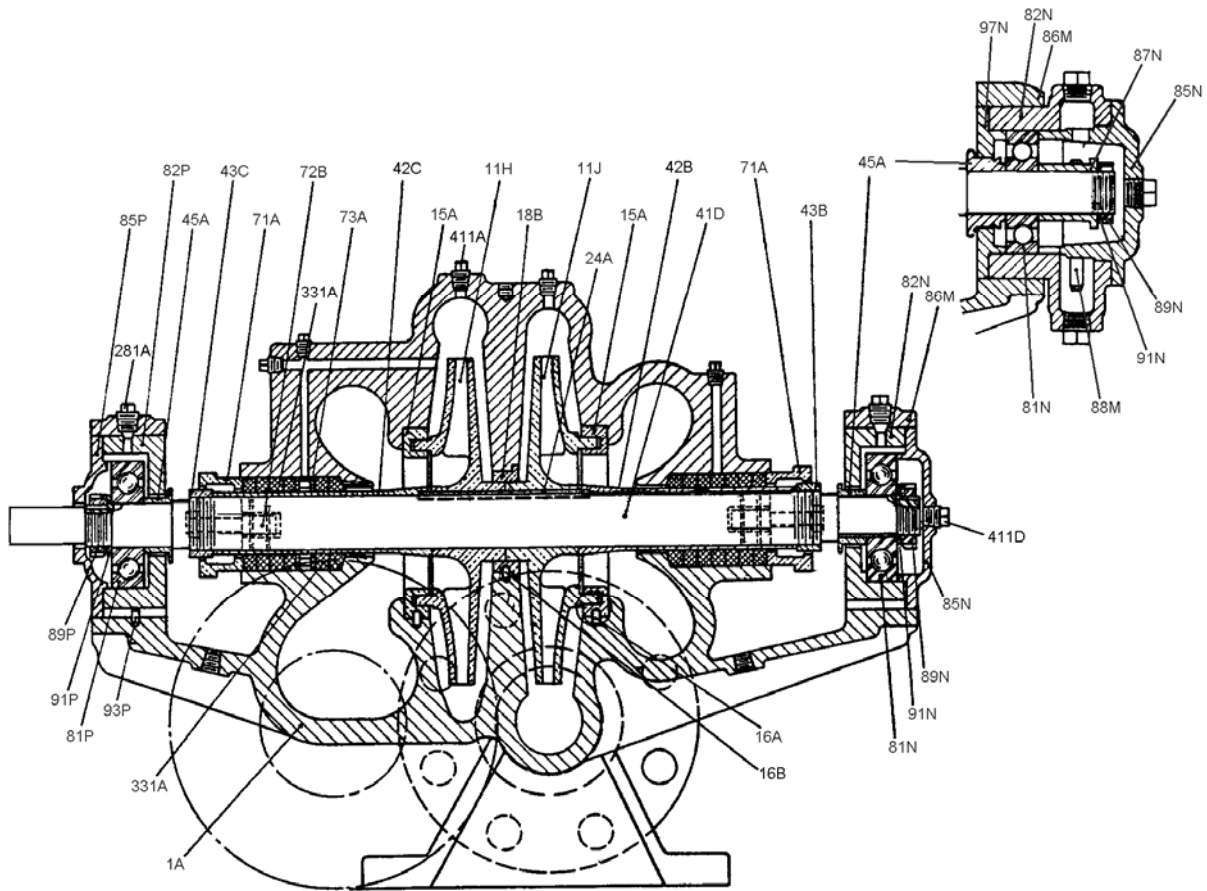

FIGURE 20 – HH Sectional Drawing



HH Sectional Drawing

Item Number	Item Description	Num. Req.
1A	Casing	1
<b>11H</b>	Impeller, 1 <sup>st</sup> Stage	1
<b>11J</b>	Impeller, 2 <sup>nd</sup> Stage	1
<b>15A</b>	Ring, Casing Wearing	2
<b>16A</b>	Pin, Dowel, Casing Ring	2
<b>16B</b>	Pin, Dowel, Casing Bushing	1
<b>18B</b>	Bushing, Casing	1
24A	Key, Impeller	1
41D	Shaft	1
<b>42B</b>	Sleeve, Shaft, RH	1
<b>42C</b>	Sleeve, Shaft, LH	1
<b>43B</b>	Shaft Sleeve Nut, RH	1
<b>43C</b>	Shaft Sleeve Nut, LH	1
<b>45A</b>	Bushing, Shaft	2
71A	Gland, Complete	2
72B	Bolt, Gland, with Nut and Washer	4
<b>73A</b>	Ring, Lantern	1
<b>81N</b>	Bearing, Ball, Outboard	1
<b>81P</b>	Bearing, Ball, Inboard	1
<b>82N</b>	Housing, Bearing, Outboard	1
<b>82P</b>	Housing, Bearing, Inboard	1

Item Number	Item Description	Num. Req.
<b>85N</b>	Cap, Housing, Outboard	1
<b>85P</b>	Cap, Housing, Inboard	1
<b>87N</b>	Spacer, Bearing	1
<b>87P*</b>	Spacer, Bearing	1
<b>88M</b>	Ring, Oil	2
86M	Strap, Housing	2
<b>89N</b>	Locknut, Bearing, Outboard	1
<b>89P</b>	Locknut, Bearing, Inboard	1
<b>91N</b>	Lockwasher, Bearing, Outboard	1
<b>91P</b>	Lockwasher, Bearing, Inboard	1
<b>93N</b>	Pin, Housing Thrust, Outboard	1
<b>93P</b>	Pin, Housing Thrust, Inboard	1
97N	Bearing Cap, Outbd/Inbd	1
97P	Bearing Cap, Inbd/Inbd	1
281A	Fitting, Zerk	2
<b>331A</b>	Packing, Stuffing Box	1 set
384C*	Screw, Bearing Cap	8
411A	Plug, Pipe, Vent	2
411D	Plug, Pipe, Bearing Cap	1
353A*	Gasket, Casing	1
381B*	Bolt, Casing	Varies

\* Not shown in sectional.

Recommended spare parts are in **BOLD**.